

WALL CLOCK KIT - DAVID



A clock is a precision mechanical instrument containing hundreds of slowly moving parts. There are over a hundred points of contact where friction works to bring it to a stop. Building any clock is challenging, and wood clocks are no different.

Take your time assembling this kit, and pay attention to the details. Great pains have been taken to craft these instructions to ensure your success. If there are any steps that seem unclear, please let us know.

Before you begin, check that there are no missing or damaged pieces in the kit. A parts list is provided to help identify each piece.

The tips and tricks section includes suggestions distilled from years of building in wood. A few minutes of reading can make a significant difference in how well your finished kit looks and operates.

Finally, read through all the instructions before you begin. It will help you understand how the various pieces fit into the final product.







DAMAGED OR MISSING PARTS?
email: service@abong.com

ABONG
i n c o r p o r a t e d

CONTENTS

Tips and Tricks	2
Parts List	4
Jig Assembly	7
Wheel Assembly	9
Axle Fitting	19
Gear Matching	33
Pendulum and Counterweight	37
Final Assembly	41
Troubleshooting	44

LEGEND

-  Hardwood Part (Laser Cut)
-  Plywood Part (Laser Cut)
-  Miscellaneous Part
-  Assembly From Previous Step

2 TIPS AND TRICKS



1. The only tools needed to assemble this kit are scissors and a 42 TPI (teeth per inch) razor saw. A set of three mini clamps are optional, but make assembly easier. You will also require two or three sheets of good quality, fine grit (180/220) sandpaper, carpenter's glue, and cyanoacrylate glue (also called crazy glue, CA, or super glue). A few craft sticks for applying glue and a block of scrap wood also comes in handy.

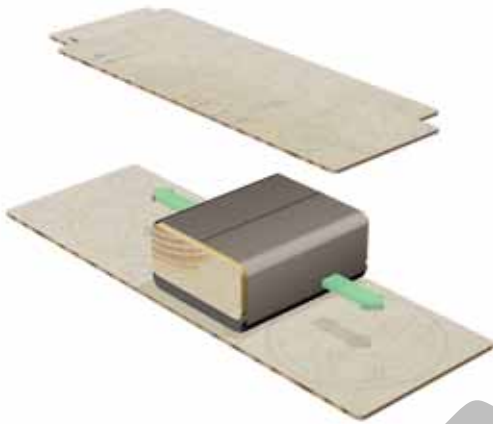

2. Using fine grit sandpaper (180/220), sand both faces of each part with the grain of the wood to remove blemishes and residue left by the laser cutting process. For large pieces, use a sanding block, which can be as simple as a piece of scrap wood with sandpaper wrapped around it.



3. For small pieces, lay the sandpaper flat and move the part against it. Take care not to remove any laser etched marks. Taking a little extra care and patience to prepare each piece will make a huge impact on the appearance of the completed kit.



4. To sand holes and smaller openings, tear a small strip of sandpaper and tightly roll it into a cone shape small enough to fit. Work the sandpaper into the opening, twirling it as it is moved in and out.



5. The decorative dark edge left by the laser cutting process is caused by natural resins in the wood. It is sticky, and does not bond well with glue. Lightly sand the dark edges that will be glued to expose the wood beneath. Don't forget that holes need to be sanded too! Before applying glue, always test the fit of the parts, carefully sanding to make any adjustments necessary.

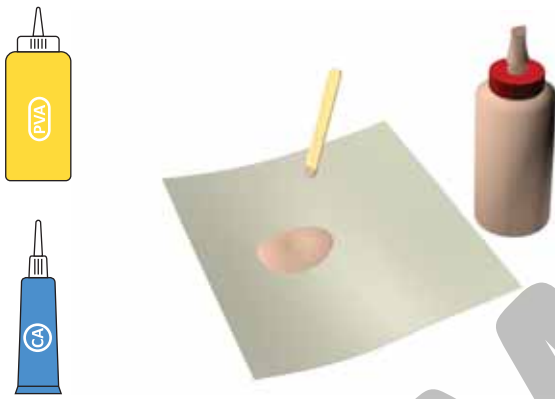

6. Use a quality PVA (polyvinyl acetate) carpenter's glue for joining wood pieces. For gluing wood to carbon fiber, use CA glue. The appropriate glue will be indicated using the symbols shown. Place a little glue onto a piece of wax paper, and use a craft stick, toothpick, or scrap of cardboard to apply the adhesive. Remove any excess with a damp paper towel before it sets.











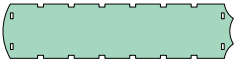

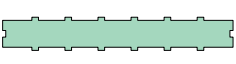









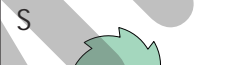

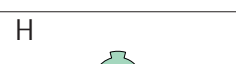



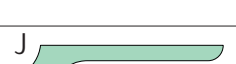







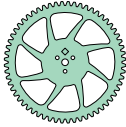



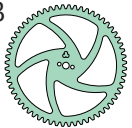

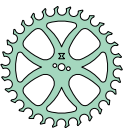
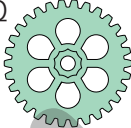



7. Wherever parts slide or rotate against each other, carefully sand the dark edges and apply graphite as a lubricant. Standard pencil "lead" is made of graphite, and works very well for this purpose. A suitable pencil has been supplied with the kit.

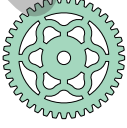





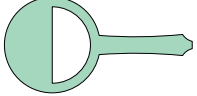

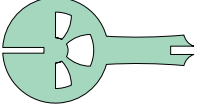
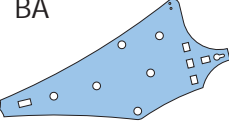
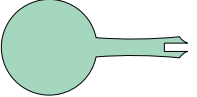
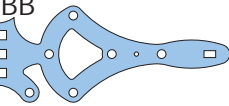



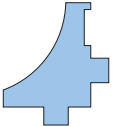

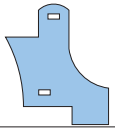
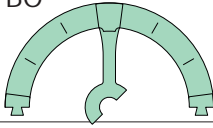
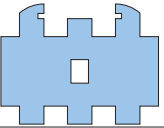
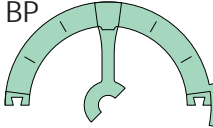

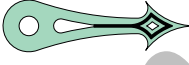

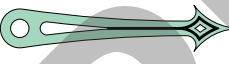



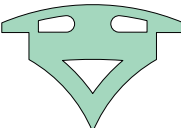



8. If you wish to apply a finish to the kit, teak oil is a simple and effective method. Carefully apply the oil to completed components before assembling them further. Avoid getting finish onto any edge or surface that will be glued or have graphite applied in later steps.

4 PARTS LIST

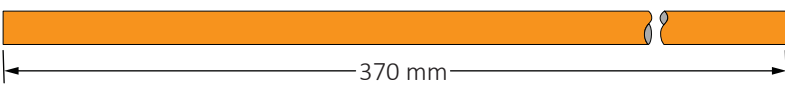
	Counterweight Face		Axle Cap
	Counterweight Side		Winder Wheel Gear
	Counterweight Top		Winder Front Frame
	Pillow Block		Winder Rear Frame
	Brace		Winder Frame Spacer
	Clip		Pawl
	Counterweight Bottom		Ratchet (S)
	Counterweight Plug Cap		Ratchet Spacer
	Counterweight Plug Retainer		Spool Core
	Counterweight Plug Spacer		Spool Flange
	Counterweight Face Trim		Great Wheel Pinion
	Pulley Flange		Great Wheel Gear
	Pulley Core		Second Wheel Pinion

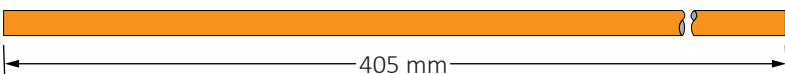
Z		Second Wheel Gear	AN		Pivot Face
AA		Common Pinion	AO		Pivot Core
AB		Third Wheel Gear	AP		Pivot Back
AC		Escape Gear	AO		Hour Idler Gear
AD		Pallet Anchor	AR		Hour Idler Spacer
AE		Pallet	AS		Hour Idler Pinion
AF		Crutch	AT		Hour Gear
AG		Stand-off	AU		Hour Hand Spacer
AI		Anchor	AV		Hour Drive Pinion
AJ		Retainer	AW		Shaft Retainer
AK		Bob Face	AX		Axle Spacer
AL		Bob Core	BA		Rear Frame
AM		Bob Back	BB		Front Frame

6 PARTS LIST

BC		Upper Frame Brace	BN		Dial Face "9"
BD		Lower Frame Spacer	BO		Dial Face Right
BE		Upper Frame Spacer	BP		Dial Face Left
BF		Cord Anchor	BQ		Hour Hand
BG		Pallet Bearing Cap	BR		Minute Hand
BH		Lower Frame Retainer	BS		Cord Guide
BI		Lower Frame Retainer Stop			Depthing Tool
BJ		Upper Frame Retainer	CA	 (x12)	Bearing
BK		Dial Face "12"	CB	 (x24)	Alignment Pin Bundle
BL		Dial Face "3"	CC	 (x2)	Pivot Pin
BM		Dial Face "6"	CD		Adjustment Screw
CE					Axle Tube
CF					Pendulum Rod
CG					Minute Axle

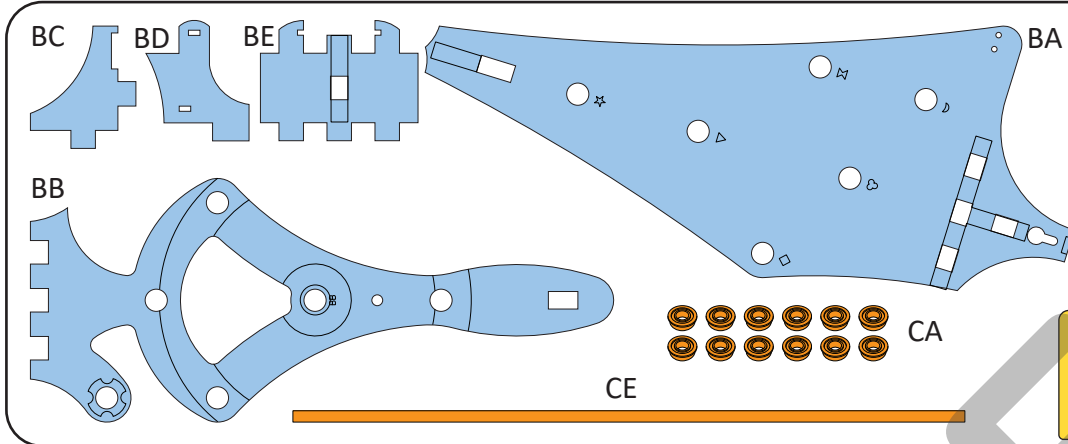

1. The frame of the clock is used as a jig to ensure all the wheels of the clock are correctly aligned with their axles.

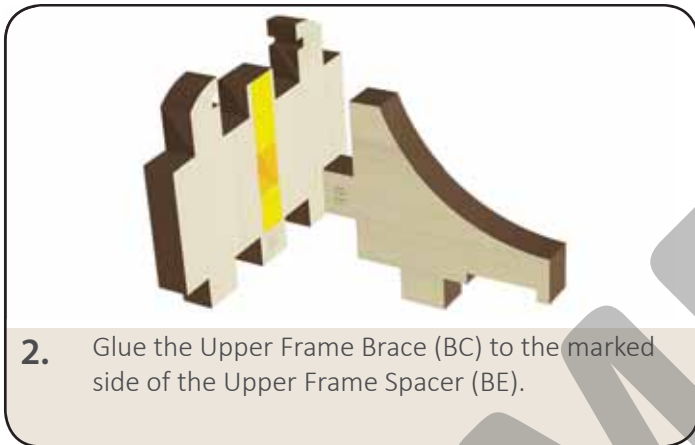

2. Glue the Upper Frame Brace (BC) to the marked side of the Upper Frame Spacer (BE).

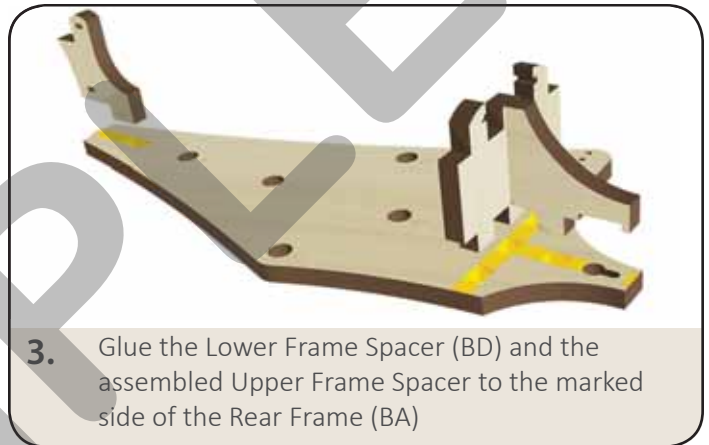

3. Glue the Lower Frame Spacer (BD) and the assembled Upper Frame Spacer to the marked side of the Rear Frame (BA).

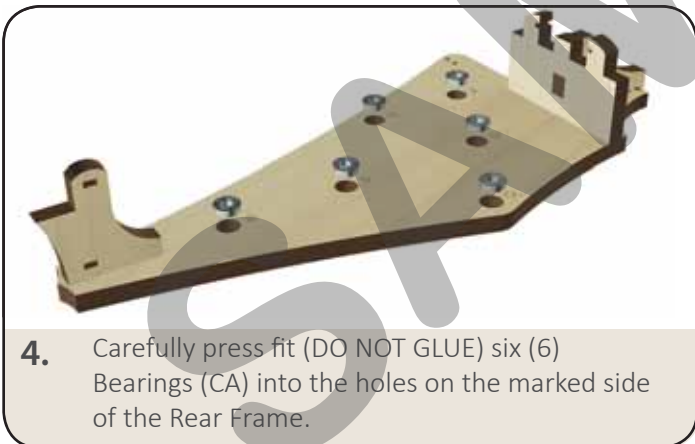

4. Carefully press fit (DO NOT GLUE) six (6) Bearings (CA) into the holes on the marked side of the Rear Frame.



5. The bearing flanges must lie flat against the Rear Frame (BA).

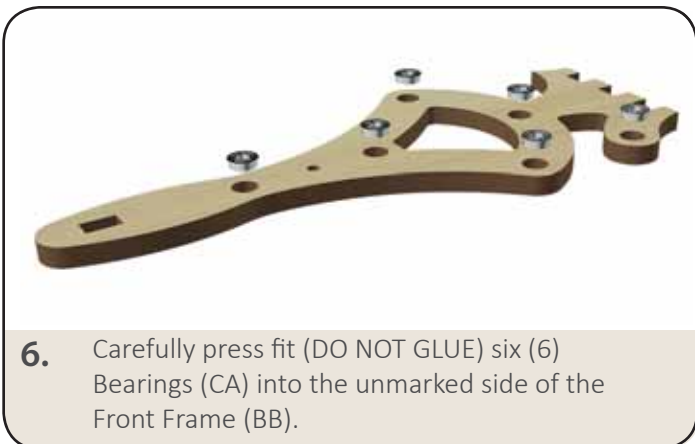

6. Carefully press fit (DO NOT GLUE) six (6) Bearings (CA) into the unmarked side of the Front Frame (BB).



7. The bearing flanges must lie flat against the Front Frame (BB).

8 JIG ASSEMBLY



8. Sand the joints so the Front Frame (BB) easily slides marked side up onto the Rear Frame Assembly as shown. (DO NOT GLUE.)



9. The Front Frame (BB) must be fully engaged with the mating parts on the base assembly.



10. Slide (DO NOT GLUE) the Axle Tube (CE) through the center bearing in the front rear frames.

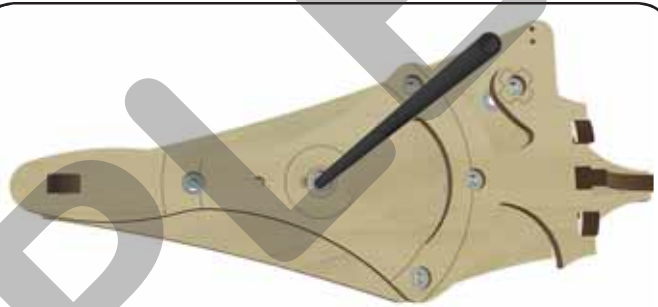

11. The completed jig assembly is ready to use.





1. Each of the wheels will be assembled using the jig. A set of three 4" quick grip clamps will make these steps easier, however painter's tape or weights can also be used to keep the largest wheel pressed firmly against the jig, and properly aligned with the shaft.

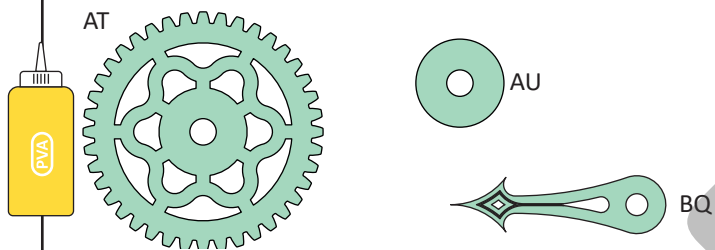

2. The hour wheel is the last stage of the dial train, slowing the hour hand down to one complete rotation once every twelve hours.

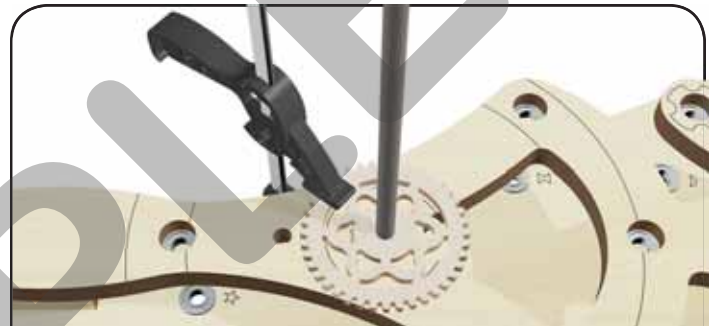

3. Fix the Hour Gear (AT) to the Jig Assembly as shown using a clamp, tape, or weights. (DO NOT GLUE.)



4. Apply a thin layer of glue to the Hour Hand Spacer (AU) and the unmarked side of the Hour Hand (BQ).

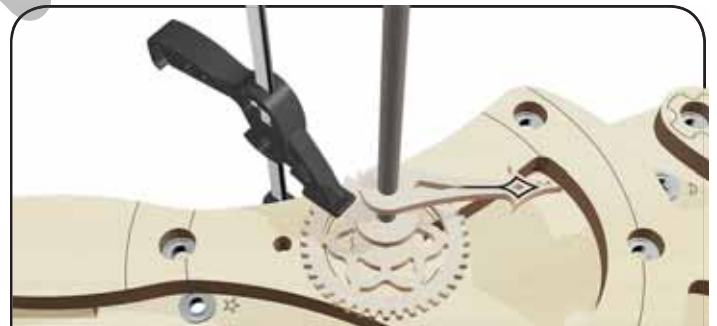

5. Press the Hour Hand Spacer (AU) and Hour Hand (BQ) onto the Hour Gear (AT).

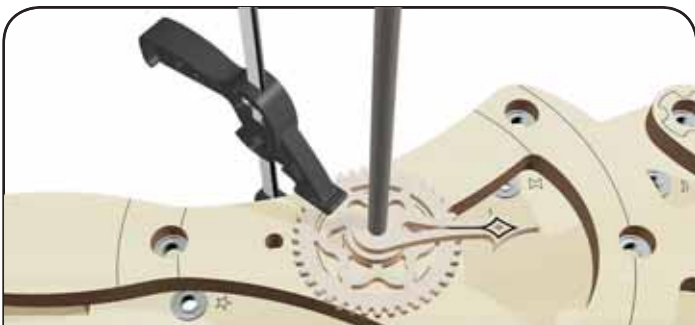

6. DO NOT GLUE the parts to the Axle Tube (CE)



7. Allow the glue to dry before removing the completed Hour Wheel. Lay it on a flat surface to check that it is not warped.

10 WHEEL ASSEMBLY

AQ

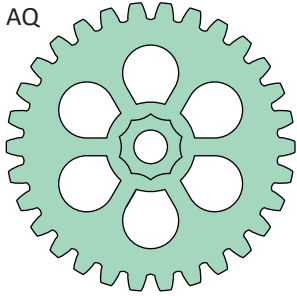

8. The Hour Idler slows the motion of the clock's hour hand, and ensures it turns in the same direction as the minute hand.

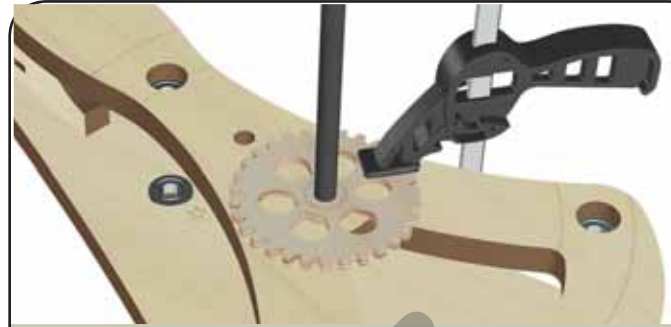

9. Fix the Hour Idler Gear (AQ) to the wheel jig marked side up using a clamp, tape, or weights. (DO NOT GLUE.)



10. Apply a thin layer of glue to the marked side of the Hour Idler Pinion (AS) and Hour Idler Spacer (AR) as shown.

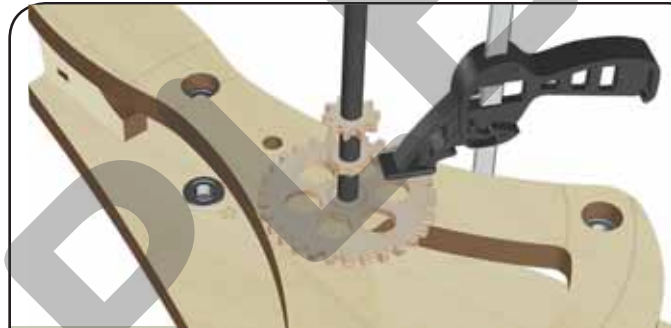

11. Press the Hour Idler Spacer (AR) and Hour Idler Pinion (AS) onto the Hour Idler Gear (AQ).

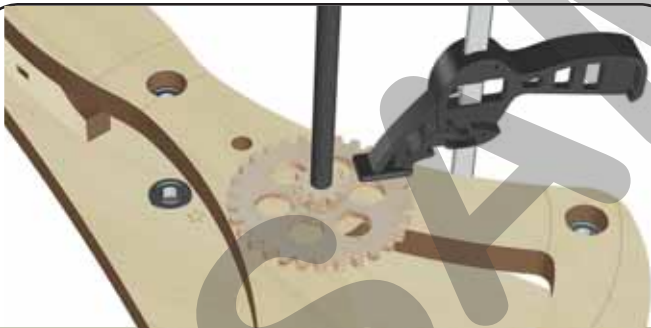

12. DO NOT GLUE the parts to the Axle Tube (CE).



13. Allow the glue to dry before removing the completed Hour Idler. Lay it on a flat surface to check that it is not warped.